

Anritsu envision : ensure

IQ Fiber Master™ MT2780A

PIM and RF Interference Analysis Over CPRI



Introducing the Anritsu THE WORLD'S ONLY AND RF ANALYZER

PIM and RF Analysis in



IQ Fiber Master MT2780A



IQ Fiber Master MT2780A

Y INTEGRATED PIM ZER OVER CPRI

the Palm of Your Hand

Key Features

- **Revolutionary**

- PIM and RF analysis using live cellular traffic over CPRI with no down time
- Frequency agnostic - all frequencies/bands supported from the same sensor

- **Convenient**

- Testing is done at the ground/BBU level
- Reports internal or external PIM and distance-to-PIM
- Supports all Tier 1 OEM base stations
- Small form factor for ease of use access to test points

- **Complimentary**

- Diagnoses PIM before taking down the site, which provides valuable information to the PIM hunting exercise
- Finds intermittent PIM to optimize scheduling of PIM hunting

Introduction

Current methods of identifying and diagnosing PIM and RF interference problems on radio access networks require taking down a site for long periods of time and performing multiple tower or rooftop climbs to get access to the RF cables needed for RF PIM testers. The IQ Fiber Master MT2780A PIM and RF analyzer is a CPRI-based solution that provides critical PIM diagnosis across multiple bands and sectors using live traffic. Utilizing a non-invasive process that allows the cell site to remain active while testing, the instrument reports real-time results so PIM hunting engineers can optimize their activities.

Quick, Non-Invasive Analysis

The IQ Fiber Master MT2780A analyzes RF data available via the CPRI link and is able to identify PIM levels, PIM location, and conduct RF spectrum analysis. This provides important diagnostic information that will help RF engineers with their PIM debugging and hunting efforts. This helps to minimize tower climbs as all analysis can be done at the baseband unit (BBU) level. In addition, since the stimulus for the PIM and RF is actual site traffic, the results represent real-world conditions that give RF engineers an accurate picture of the environment.

Up to three downlinks and one uplink can be monitored during testing. This allows a multi-band analysis that provides users with a clear picture of which transmitter is the largest contributor to PIM. This is ideal in the case of multi-band sites or 4x4 MIMO antennas.

Monitors Site to Solve Intermittent PIM Problems

The ability to conduct tests while the cell site remains live enables the IQ Fiber Master MT2780A to watch for PIM “events” or intermittent PIM that are hard to capture and characterize. When continuously monitoring a site for days or weeks without any intervention, the instrument will automatically record and capture PIM events with corresponding time stamps so an RF technician can debug these problems faster.

Supports All Current Equipment and Configurations

The IQ Fiber Master MT2780A uses sophisticated signal processing algorithms to perform PIM analysis and support all 4G/LTE bands and bandwidths as well as MIMO configurations up to 4x4 MIMO in a single box. It also supports CPRI link rates 1 – 8 as well as equipment from all major manufacturers, including Ericsson, Nokia, Huawei, and Samsung.

Clear, Fast Diagnosis of PIM and RF

Results are presented in both graphical and report formats. RF results are presented in a spectrum analyzer type of format. PIM results include reports for PIM levels and pass/fail conditions, as well as graphs for PIM-over-time and distance-to-PIM (DTP).

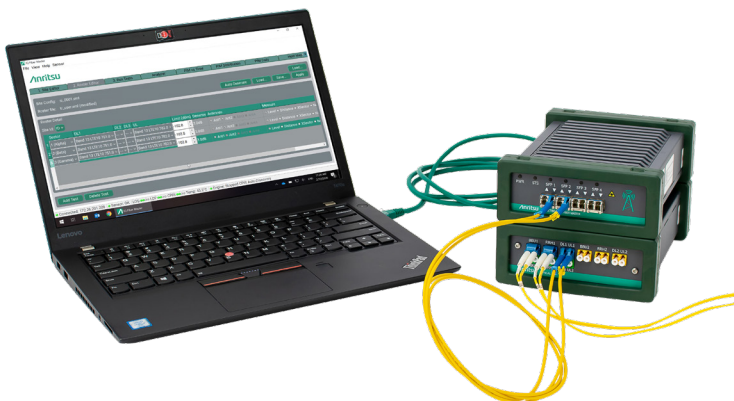

Features and Benefits

Significantly Reduce the Time for RF and PIM Interference Hunting

- Immediate access to the RF spectrum via the CPRI link – no need to climb the tower or rooftop to get access to the uplink signal
- Monitor up to 4 CPRI links and 12 sectors simultaneously
- Automated PIM analysis functions so results are obtained quickly and easily
- Long-term monitoring functions allows unsupervised analysis of hard-to-find, intermittent RF issues
- Automatic report creation so users do not need to hunt for critical information

Accurate Results Using Advanced Signal Processing Algorithms

- Uses real RF signals to calculate RF spectrum and PIM, so results represent real-world data
- Robust PIM analysis can accurately analyze up to 4x4 MIMO configurations
- RF resolution bandwidth from 117 Hz to 30 KHz based on 30.72 MB/s CPRI data rate
- PIM power level accuracy ± 1 dB (RMS level of digital PIM power on CPRI)

The Most Cost-Effective Solution on the Market

- All current bands and bandwidths supported on a single platform — no need for separate instruments for each band
- PIM and RF spectrum analysis functions from a single test instrument
- Small and lightweight to reduce field space requirements
- Options are tailored to suit your use model
- Vendor support for Ericsson, Huawei, Nokia, and Samsung
- Supports all LTE bandwidths (5, 10, 15, 20 MHz)
- MIMO support for 1x2, 2x2, 2x4, and 4x4
- Support for CPRI line rates 1 - 8
- Software and future updates are available for download from the Anritsu website. (A properly licensed IQ Fiber Master sensor is required to operate the software.)

Connection Diagrams

The IQ Fiber Master MT2780A uses an optical tap to extract the IQ data from the CPRI link. Once installed, the BBU and remote radio head (RRH) can continue to operate as normal with zero impact on network performance.

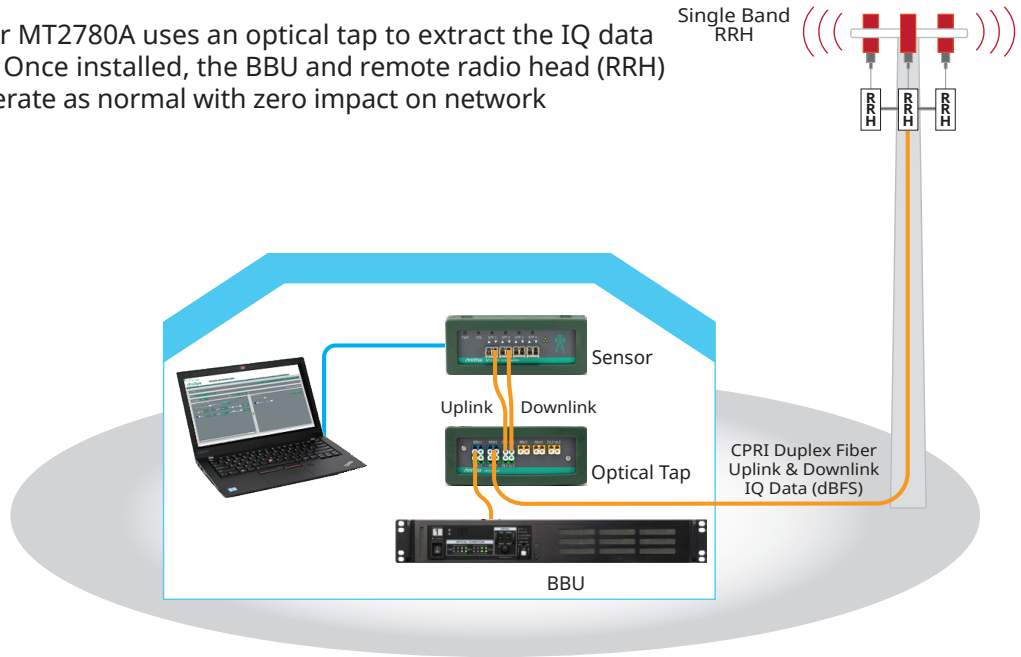

Single Band Connection Diagram

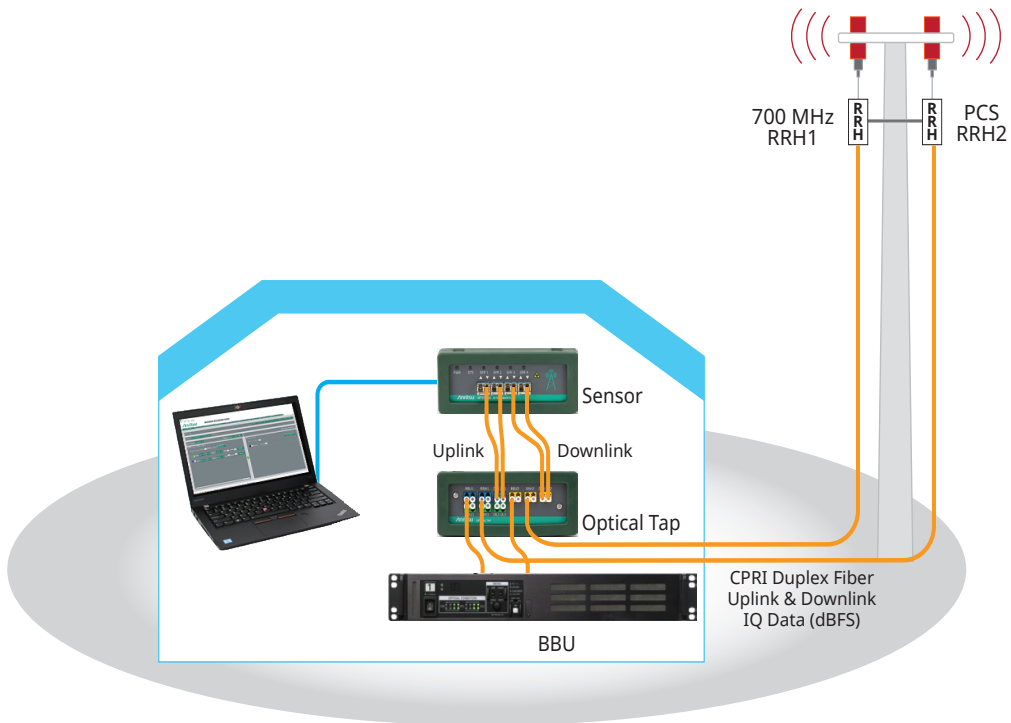

Dual Band Connection Diagram

Features Built to Deliver Results Easily and Quickly

Unmatched Analysis Accuracy

By extracting live RF data from the CPRI link, all inputs used during analysis are real RF frequencies and power levels, not simulated ones. This eliminates the need to decide what single frequency to use for PIM analysis and leverages the complete bandwidth of the transmitting signal. This is critically important in today's multi-carrier, multi-band cell towers where the spectrum is crowded and complex.

Complete, Easy-to-Read Reporting

Customizable reports are available after every test run and allow the site's RF performance to be fully documented. Results include:

- Site configuration information
- Optical and SFP checks
- RF spectrum display
- PIM heat map showing transmitters with the highest PIM contribution
- PIM analytics showing long-term monitoring results

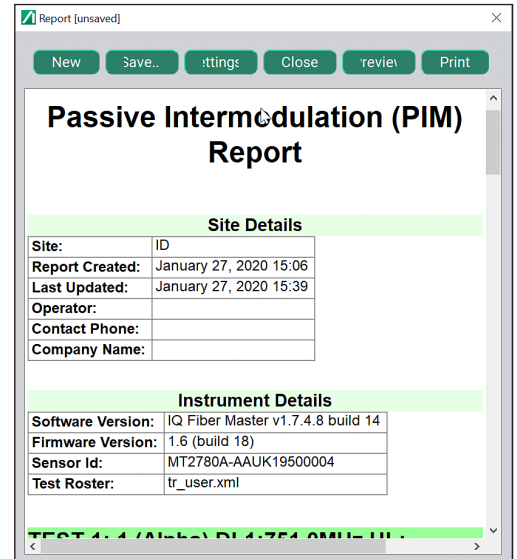

Rugged and Compact Form Factor

Traditional PIM testers are inherently heavy because of the battery and electronics needed to generate their test signals. Since the IQ Fiber Master MT2780A uses the actual radio to generate its signals, its form factor is small and lightweight. The IQ Fiber Master sensor unit and tap together weigh less than 3 kg and can both fit in the palm of your hand. This allows for extreme portability to take from site to site and will not take excessively truck space. Since it can be left in the base station hut for medium- to long-term testing, this small form factor will not occupy significant space to do the job.

A laptop computer is used to control the sensor unit via an Ethernet connection. (Laptop computer is not included).



Modern Application Provides Fast and Easy Setup

The IQ Fiber Master MT2780A is designed for easy setup and use. The MT2780A is controlled by MX280020A IQ Fiber Master Control software that runs on a PC/laptop. The software will automatically check (if PC/laptop is connected to the cloud) if it has the latest version of software and which license are enabled. The MX280020A provides the tools needed for configuring the CPRI connection, the various PIM over CPRI test scenarios, and the actual measurements. The menus have been created in wizard-like fashion, allowing new users to get results quickly. While translation from physical bands and antenna sectors to CPRI parameters is notoriously confusing, the application creates an intuitive environment that can automatically map the respective parameters together — saving both time and frustration.

More importantly, the results are presented in an easy-to-read format so the user can quickly make decisions on how to remove or mitigate the interference problems. There are two basic types of analysis: RF spectrum analysis and PIM analysis.

The MX280020A IQ Fiber Master Control software is a free download (from the MT2780A product page). The MX280020A requires a MT2780A (licenses on unit) to enable full functionality.

Automated Fiber and CPRI Setup

The tool provides either manual or automatic setup of the CPRI IQ parameters. In the automatic setup mode, the data link speed, IQ setup, and antenna container groups are configured appropriately without any user intervention. The bands are then available to be defined for each data stream.

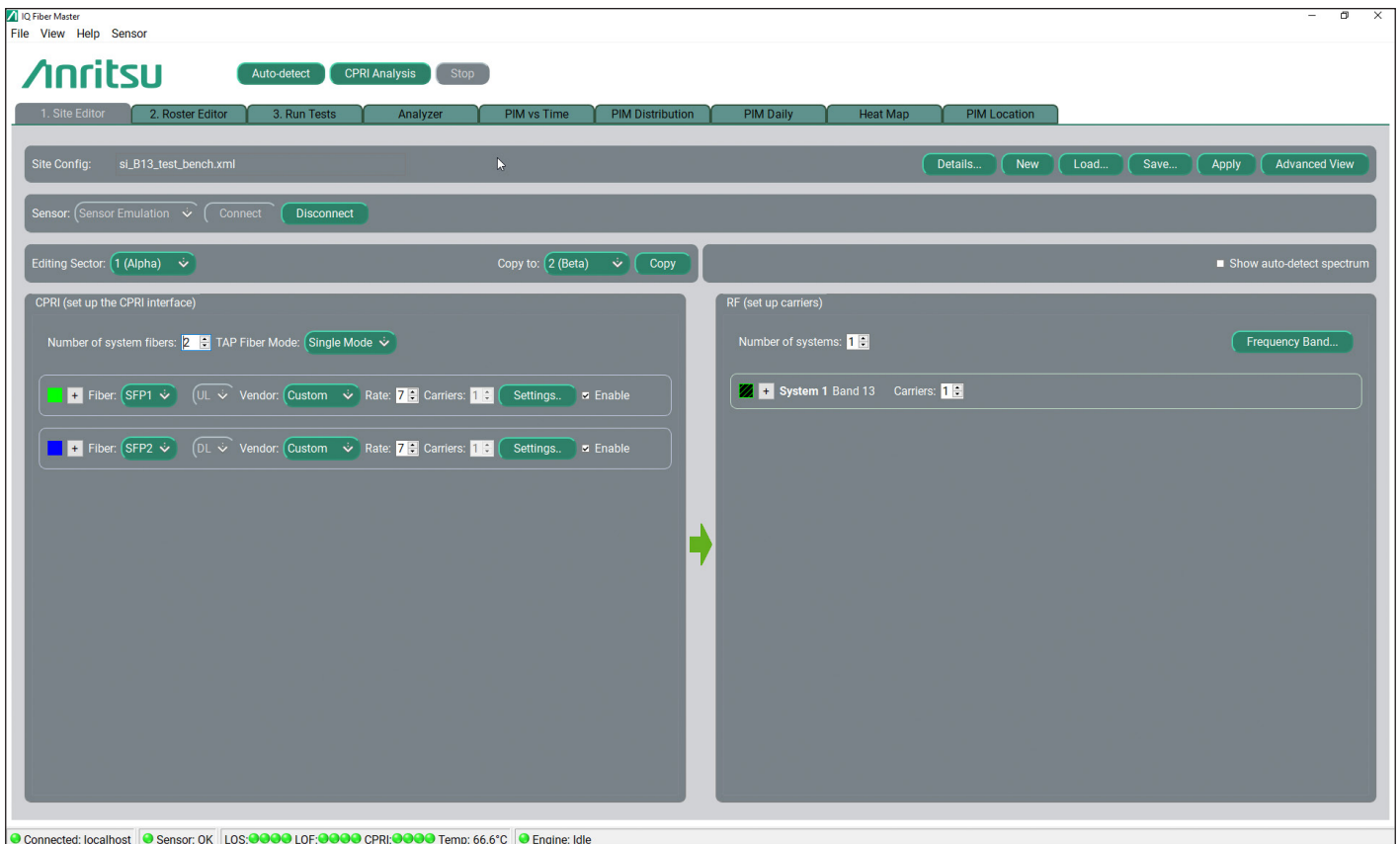

Automated Fiber and CPRI Setup Screen

Features: Diagram and Test Roster

A connection diagram map is conveniently provided to assist in connecting the IQ Fiber Master MT2780A and optical tap to the BBU/RRH network.

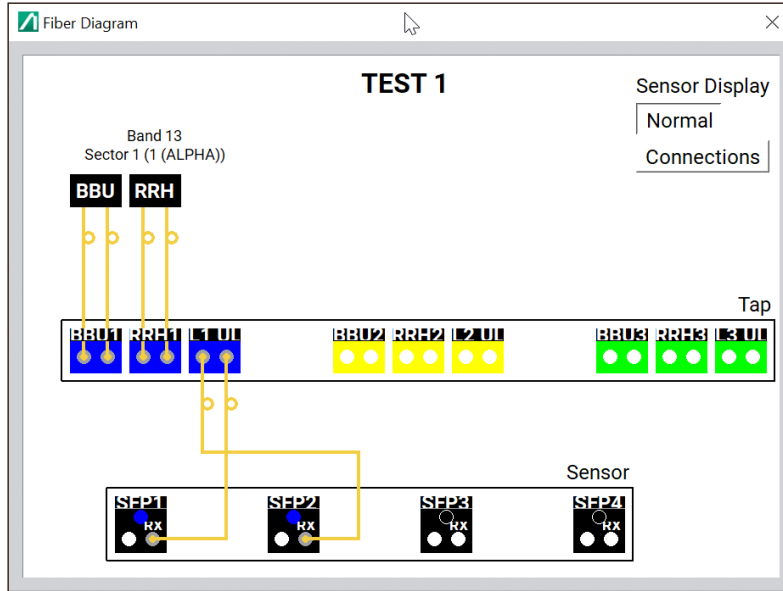

CPRI Fiber Connection Diagram

Test Roster Combinations Automatically Generated

Different combinations of downlink transmitters can introduce PIM components into the uplink channels present. In some cases, the bands that are causing the PIM are known, and this case the combination of transmitters can be manually set. In the case where the transmit bands causing the PIM are unknown, the user can use the Auto Generate function to create the different test scenarios that may be causing the PIM.



1. Site Editor | 2. Roster Editor | 3. Run Tests | Analyzer | PIM vs Time | PIM Distribution | PIM Daily | Heat Map

Site Config: si_0001.xml Load...
 Roster file: tr_user.xml (modified) Auto Generate Load... Save... Apply

Roster Detail
 Site ID: ID

Sector	DL1	DL2	DL3	UL	Limit (dBm)	Desense	Antennas	Measure
1 (Alpha)	Band 13 LTE10 751.0	---	---	Band 13 LTE10 782.0	-102.8	3.0dB	Ant1 Ant2 Ant3 Ant4	Level Distance XSector Ni
2 (Beta)	Band 13 LTE10 751.0	---	---	Band 13 LTE10 782.0	-102.8	3.0dB	Ant1 Ant2 Ant3 Ant4	Level Distance XSector Ni
3 (Gamma)	Band 13 LTE10 751.0	---	---	Band 13 LTE10 782.0	-102.8	3.0dB	Ant1 Ant2 Ant3 Ant4	Level Distance XSector Ni

Add Test Delete Test

Connected: 172.26.201.208 | Sensor: OK | LOS: | LOF: | CPRI: | Temp: 45.2°C | Engine: Stopped CPRI Auto-Discovery

Test Roster Screen Details List of PIM Tests to be Run

Features: Configuration and RF Spectrum

Configuration Checks Network Setup

Before performing the PIM tests, the IQ Fiber Master MT2780A will check the configuration to validate the proper network setup. The CPRI link is checked for correct rate and IQ configuration. The SFPs are also checked to ensure the data streams are being received properly. The RF spectrum can be shown at this point to ensure the spectrum looks as expected.

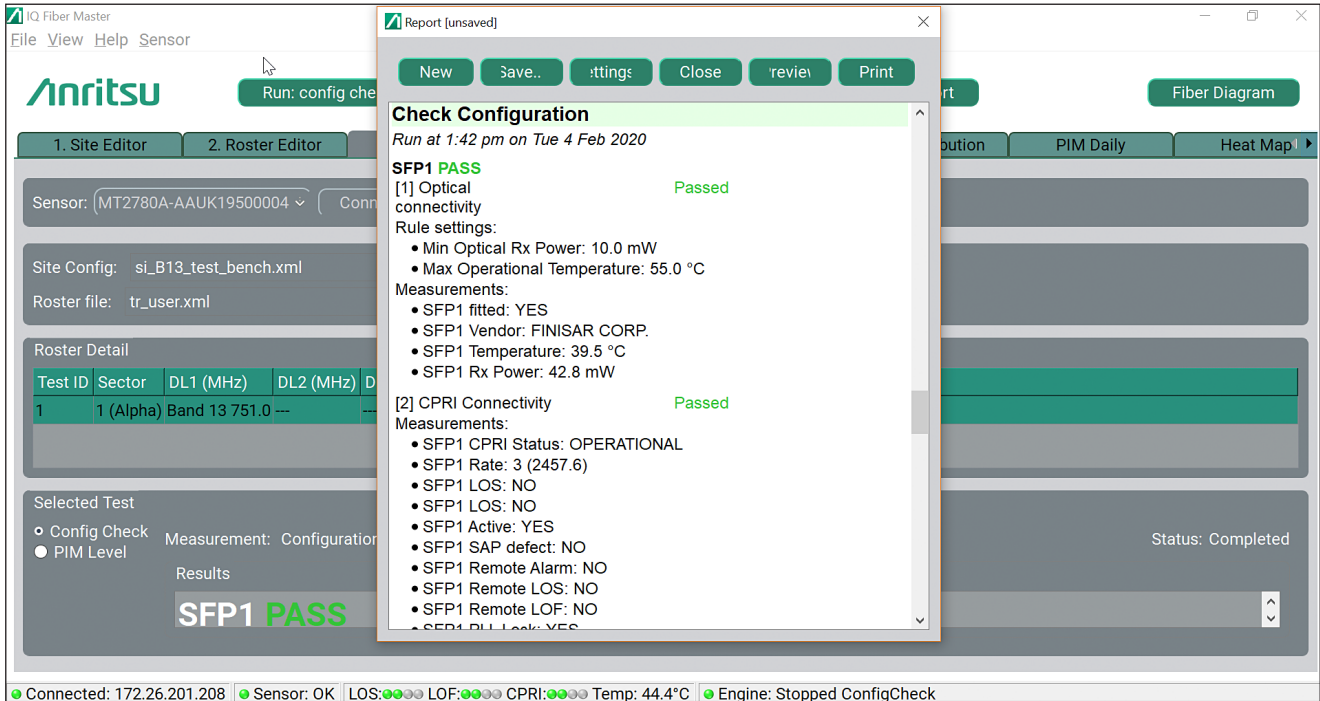

Configuration Checks Ensure All Fiber and CPRI Connections are Working Properly

Features: RF Spectrum and PIM Test Roster — Option 0752

RF Spectrum Analysis for Interference Hunting

The RF spectrum analyzer provides the user with a frequency domain view of the RF spectrum, much like a spectrum analyzer. Up to 12 traces of the uplink, downlink, or a mix-and-match can be displayed simultaneously. The waveform has several options in which to display the RF data:

- Normal spectrum view
- Markers
- Persistence
- Peak/min hold
- Spectrogram

The GUI contains various plot options to display the spectrum in ways to enhance the view of the spectrum in question. In addition, the allows playback of previously capture signals so the user can analyze the spectrum offline.

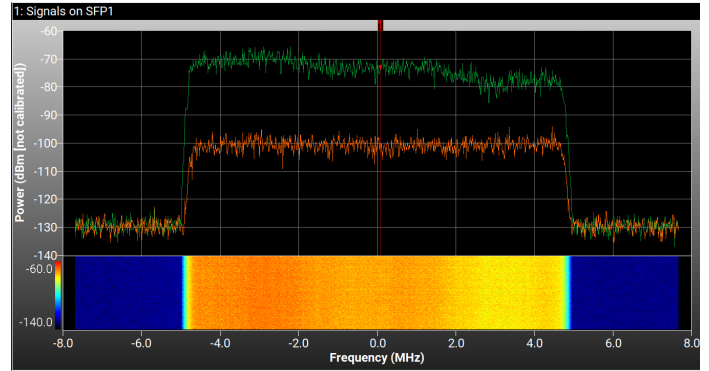

Accurate PIM Analysis to Characterize and Locate PIM — Option 0754

The advanced PIM analysis algorithms, using data from both the downlink and uplink, are able to detect and calculate true PIM levels that may be present. Accuracy is assured since live cellular data traffic is used.

• List of PIM Test Scenarios (Test Roster)

Several PIM scenarios can be tested during the same test run. A combination of single or multiple DL transmissions and the corresponding UL PIM levels are listed in this test roster window.

Anritsu

1. Site Editor | 2. Roster Editor | 3. Run Tests | Analyzer | PIM vs Time | PIM Distribution | PIM Daily | Heat Map

Site Config: si_0001.xml Load...
 Roster file: tr_user.xml (modified) Auto Generate Load... Save... Apply

Roster Detail
 Site Id: ID

Sector	DL1	DL2	DL3	UL	Limit (dBm)	Desense	Antennas	Measure
1 (Alpha)	Band 13 LTE10 751.0	---	---	Band 13 LTE10 782.0	-102.8	3.0dB	Ant1 Ant2 Ant3 Ant4	Level Distance XSector N
2 (Beta)	Band 13 LTE10 751.0	---	---	Band 13 LTE10 782.0	-102.8	3.0dB	Ant1 Ant2 Ant3 Ant4	Level Distance XSector N
3 (Gamma)	Band 13 LTE10 751.0	---	---	Band 13 LTE10 782.0	-102.8	3.0dB	Ant1 Ant2 Ant3 Ant4	Level Distance XSector N

Add Test Delete Test

Connected: 172.26.201.208 | Sensor: OK | LOS: | LOF: | CPRI: | Temp: 45.2°C | Engine: Stopped CPRI Auto-Discovery

Features: PIM Analytics — Option 0755

• Pass/Fail PIM Test

Patented algorithms are used to produce a pass/fail report displays graphically, whether the PIM is isolated to problems in the network equipment (internal) or is caused by conditions outside the equipment (external). There are two important parameters reported in this test:

- PIM level: The actual PIM level is calculated by a proprietary algorithm that uses the downlink signal to build a detailed mathematical model of the PIM affecting the uplink. This PIM is then correlated with the real uplink signal so any actual PIM present is easily identified.

- RX desens: This is a desensitization metric in dB that indicates how much the uplink channel noise floor has been raised due to PIM.

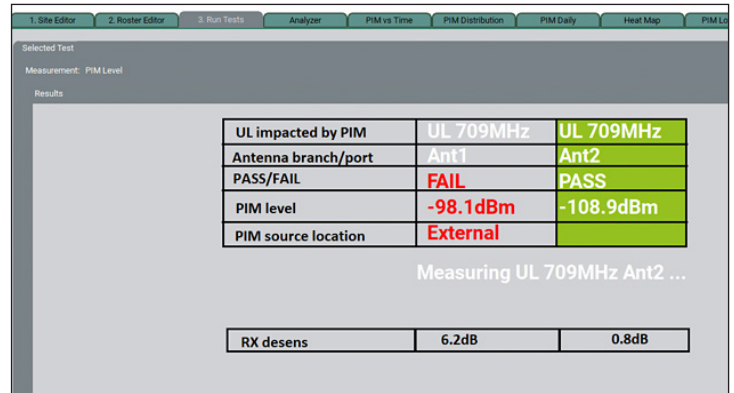

Pass/Fail PIM Test Report

• Distance-to-PIM

The distance to the most dominant PIM source is calculated and displayed in graphical format. Note: A calibration step is needed where a known PIM source (provided) is placed in front of the antenna. The radio is then set to high and low power and RF levels are recorded.



Distance-to-PIM

• Automated Reports

Each PIM analysis run outputs a formal report file detailing the PIM analysis results. This can be used offline for further analysis or for site record keeping to see the RF environment changes over time.

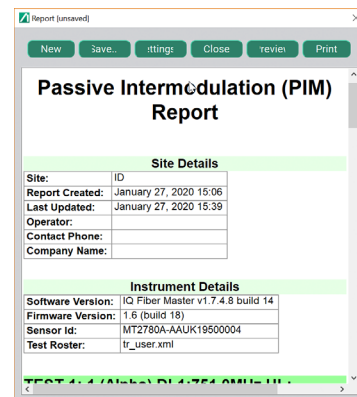

Automated Reports

Features: PIM Analytics (Cont'd)

PIM Analytics Provides In-Depth Monitoring and Data Analysis

The PIM analytics module monitors PIM results over time and generates various reports. This will give users insight into PIM trends and also allow capture of hard to find intermittent PIM problems.

- PIM versus Time**

Longer term monitoring for PIM helps record and detect PIM levels that are intermittent. Event logs are available to record user-defined alarm conditions. These results are presented in a PIM versus Time graph and can be accessed remotely.

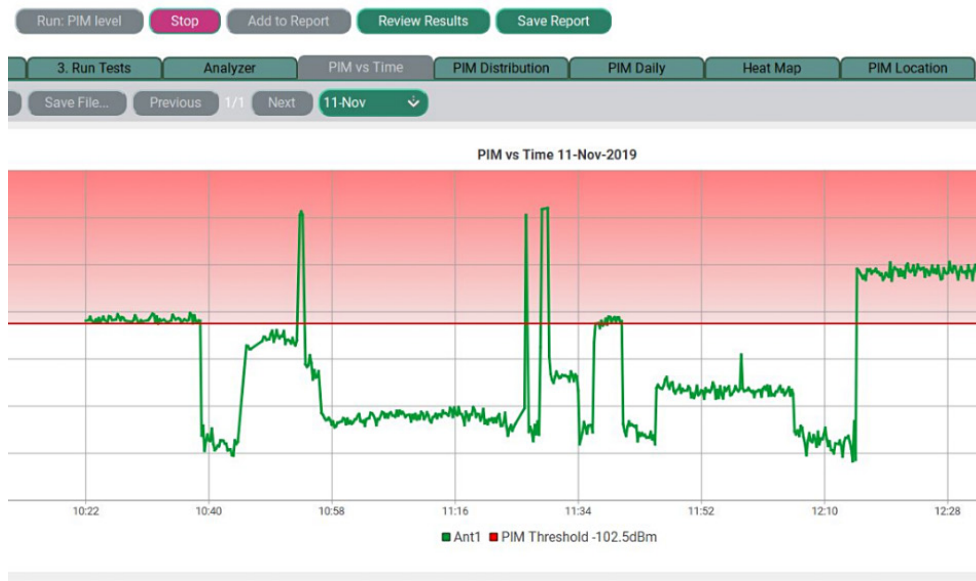

PIM versus Time Graph

- PIM Heat Map Analysis**

An important part of PIM analysis is to determine the highest contributing transmitter to the PIM levels. With the IQ Fiber Master MT2780A exclusive heat map function, this can be easily determined. Not only can the user see the results graphically, but a heat map summary will report a description of the possible location and highest offending source so the technician can quickly know where the PIM sources originate.

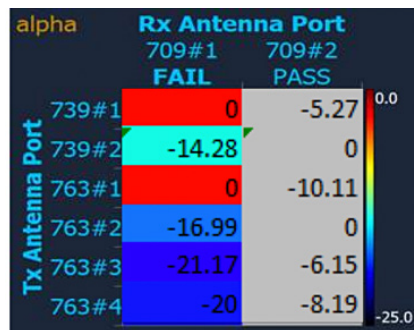

Heatmap Summary	
Internal/External	PIM is likely to be INTERNAL on UL 782MHz Ant1 caused by DL 751MHz Ant2
Internal/External	No pim found on UL 782MHz Ant2

PIM Heatmap and Heatmap Summary

Applications

RF Interference Hunting

The IQ Fiber Master MT2780A provides an easy way to look at the RF spectrum of live traffic of any sector. The user can identify interference sources that may be present inside the band. The display is fast enough to display both static and dynamic interference sources. Users can further characterize the interference source through the use of various display options, such as the spectrum waterfall and resolution bandwidth adjustments.

Since up to 12 sectors can be displayed at once, the approximate direction or location of the interference source can be extrapolated. Sources that display higher power on one sector versus the others will help determine a general direction that will assist the site engineers locating the problem. Once a general direction is determined, specific interference hunting tools such as the PIM Master™ MW82119B passive intermodulation analyzer used in conjunction with a PIM Hunter™ connected to either a Spectrum Master™ MS271xE handheld spectrum analyzer or Site Master™ analyzer with spectrum analyzer option can be used to pinpoint the interferer.

PIM Analysis and Diagnosis

The IQ Fiber Master MT2780A shines in instances where you have degraded KPIs and are unsure whether PIM is the culprit. In this case, determining the existence of PIM and its severity is simply done with the push of the button. Automatic test scenarios allow quick determination of the presence of PIM.

If PIM is present, the equipment can be left at the BBU location for days or weeks and remotely monitored. PIM events are captured in a log file and stored for later review.

If PIM is present at unacceptable levels, the next step is to determine the location of the offending source. The tool can first start with analyzing whether the PIM is internal to the radio equipment or caused by conditions in the external environment. This is accomplished by the DTP function, which reports the approximate distance to the PIM source from the antenna. A negative number indicates internal PIM, while a positive number indicates the source is in the environment.

Locating the PIM source is essential to site engineers and technicians for speedy resolution. External PIM sources can be pinpointed to their exact location and sources with the PIM Master MW82119B solution.



Example Case Study: PIM From PCS and AWS Bands

Multi-Band Analysis

Most modern cell sites service multiple bands. This creates a scenario where 2 or 3 different bands can produce PIM products in the uplink of these band. A good example is the AWS/PCS scenario below.

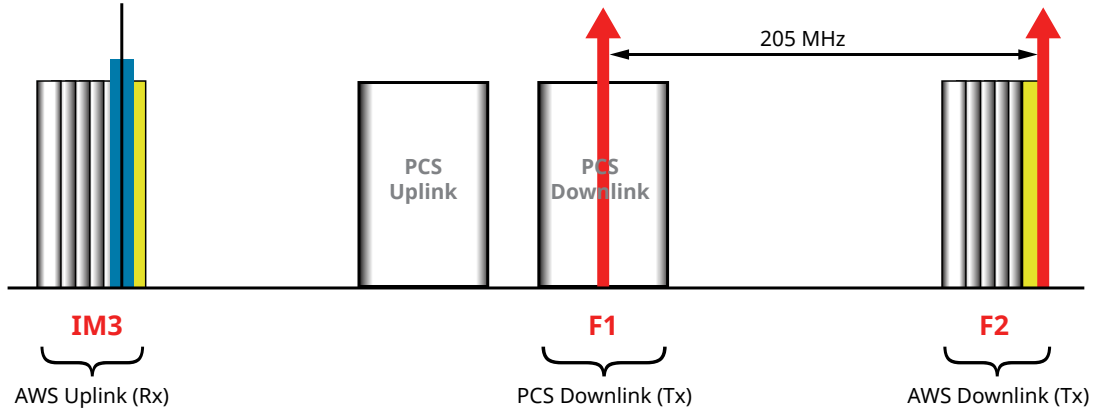

PIM Example: PCS and AWS Transmitters Producing PIM Product in the AWS Uplink

Analyzing this scenario is quite difficult with PIM hunting tools, as transmitting two different bands simultaneously will require two different pieces of test equipment hauled up to the rooftop or tower. Choosing and simulating the correct frequencies is also tedious as the bands must be swept in coordination to simulate the PIM situation. With the IQ Fiber Master MT2780A, support for four CPRI links is available which makes analyzing this multi-band PIM scenario easy. Each respective link is plugged into the sensor and the measurement of PIM in the AWS uplink channel will automatically be reported.

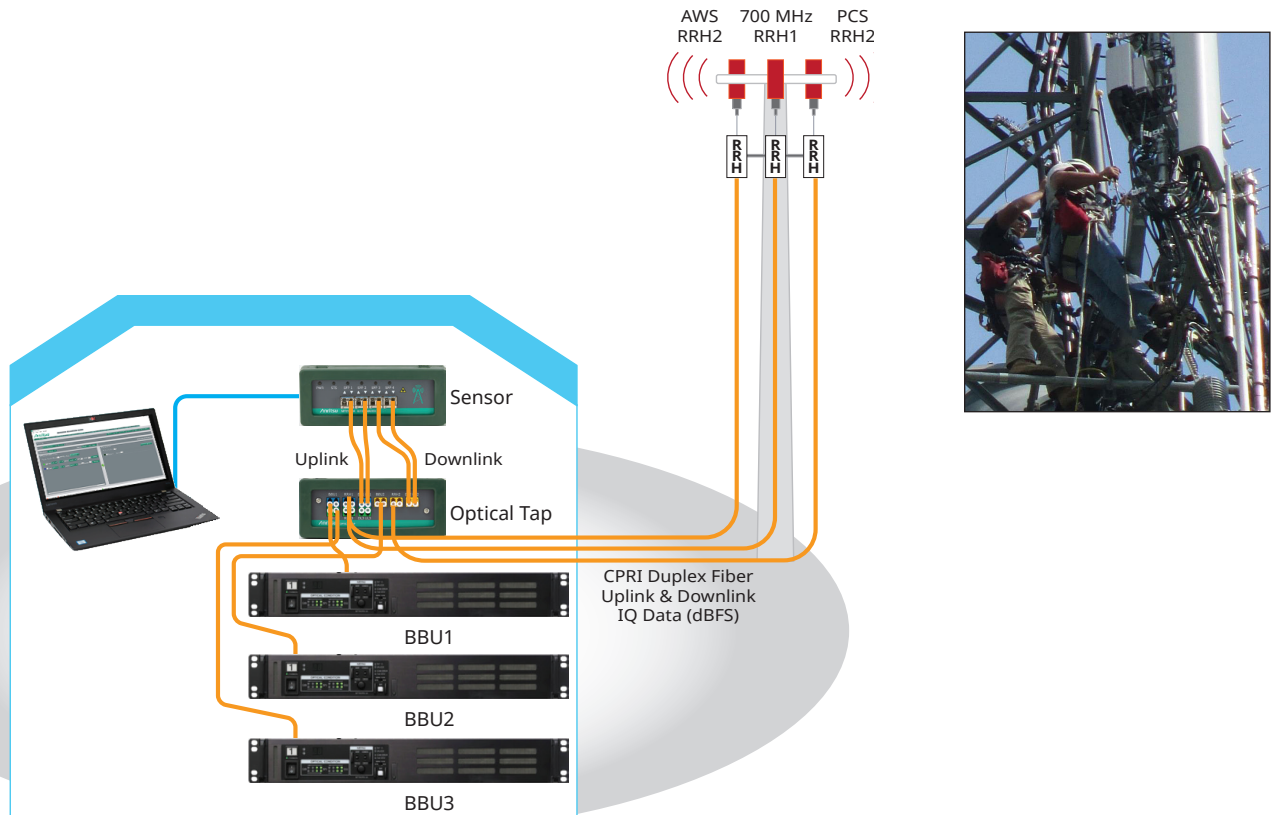

Multi-Band Connection Diagram

IQ Fiber Master MT2780A

Product Interfaces



MT2780A Front Panel

- Indicator lights for power, sensor, and SFP status
- SPF cages



MT2780A Rear Panel

- PC Ethernet connector
- SYNC A/SYNC B are unused
- Power connector
- USB and USB mini (for future use)



2000-1977-R Optical TAP Front Panel

- Up to 3 sectors per TAP
- Multi-mode or single-mode available

Ordering Information

Model Number

MT2780A

MT2780A-0752

MT2780A-0754

MT2780A-0755

2000-1981-R

2000-1977-R

2000-1978-R

MX280020A

Description

IQ Fiber Master 4-Port CPRI Main Sensor Unit (requires option 752, minimum)

LTE RF over CPRI (requires MT2780A)

PIM over CPRI (requires option 752)

PIM Analytics (requires options 752 and 754)

Hard Carrying Transit Case

Optical Tap Single-Mode

Optical Tap Multi-Mode

IQ Fiber Master Control Software (Downloadable from Anritsu.com)

Note

• **United States**

Anritsu Company

450 Century Parkway, Suite 190, Allen,
TX 75013 U.S.A.
Phone: +1-800-Anritsu (1-800-267-4878)

• **Canada**

Anritsu Electronics Ltd.

700 Silver Seven Road, Suite 120,
Kanata, Ontario K2V 1C3, Canada
Phone: +1-613-591-2003
Fax: +1-613-591-1006

• **Brazil**

Anritsu Eletrônica Ltda.

Praça Amadeu Amaral, 27 - 1 Andar
01327-010 - Bela Vista - Sao Paulo - SP - Brazil
Phone: +55-11-3283-2511
Fax: +55-11-3288-6940

• **Mexico**

Anritsu Company, S.A. de C.V.

Blvd Miguel de Cervantes Saavedra #169 Piso 1, Col. Granada
Mexico, Ciudad de Mexico, 11520, MEXICO
Phone: +52-55-4169-7104

• **United Kingdom**

Anritsu EMEA Ltd.

200 Capability Green, Luton, Bedfordshire LU1 3LU, U.K.
Phone: +44-1582-433200
Fax: +44-1582-731303

• **France**

Anritsu S.A.

12 avenue du Québec, Batiment Iris 1-Silic 612,
91140 VILLEBON-SUR-YETTE, France
Phone: +33-1-60-92-15-50
Fax: +33-1-64-46-10-65

• **Germany**

Anritsu GmbH

Nemetschek Haus, Konrad-Zuse-Platz 1
81829 München, Germany
Phone: +49-89-442308-0
Fax: +49-89-442308-55

• **Italy**

Anritsu S.r.l.

Via Elio Vittorini 129, 00144 Roma Italy
Phone: +39-06-509-9711
Fax: +39-6-502-2425

• **Sweden**

Anritsu AB

Isafjordsgatan 32C, 164 40 KISTA, Sweden
Phone: +46-8-534-707-00

• **Finland**

Anritsu AB

Teknobulevardi 3-5, FI-01530 VANTAA, Finland
Phone: +358-20-741-8100
Fax: +358-20-741-8111

• **Denmark**

Anritsu A/S

Torveporten 2, 2500 Valby, Denmark
Phone: +45-7211-2200
Fax: +45-7211-2210

• **Russia**

Anritsu EMEA Ltd.

Representation Office in Russia

Tverskaya str. 16/2, bld. 1, 7th floor.
Moscow, 125009, Russia
Phone: +7-495-363-1694
Fax: +7-495-935-8962

• **Spain**

Anritsu EMEA Ltd.

Representation Office in Spain

Edificio Cuzco IV, Po. de la Castellana, 141, Pta. 5
28046, Madrid, Spain
Phone: +34-915-726-761
Fax: +34-915-726-621

• **United Arab Emirates**

Anritsu EMEA Ltd.

Dubai Liaison Office

902, Aurora Tower,
P O Box: 500311- Dubai Internet City
Dubai, United Arab Emirates
Phone: +971-4-3758479
Fax: +971-4-4249036

• **India**

Anritsu India Pvt Ltd.

6th Floor, Indiqube ETA, No.38/4, Adjacent to EMC2,
Doddanekundi, Outer Ring Road, Bengaluru - 560048, India
Phone: +91-80-6728-1300
Fax: +91-80-6728-1301

• **Singapore**

Anritsu Pte. Ltd.

11 Chang Charn Road, #04-01, Shriro House
Singapore 159640
Phone: +65-6282-2400
Fax: +65-6282-2533

• **P. R. China (Shanghai)**

Anritsu (China) Co., Ltd.

Room 2701-2705, Tower A,
New Caohejing International Business Center
No. 391 Gui Ping Road Shanghai, 200233, P.R. China
Phone: +86-21-6237-0898
Fax: +86-21-6237-0899

• **P. R. China (Hong Kong)**

Anritsu Company Ltd.

Unit 1006-7, 10/F., Greenfield Tower, Concordia Plaza,
No. 1 Science Museum Road, Tsim Sha Tsui East,
Kowloon, Hong Kong, P. R. China
Phone: +852-2301-4980
Fax: +852-2301-3545

• **Japan**

Anritsu Corporation

8-5, Tamura-cho, Atsugi-shi, Kanagawa, 243-0016 Japan
Phone: +81-46-296-6509
Fax: +81-46-225-8352

• **Korea**

Anritsu Corporation, Ltd.

5FL, 235 Pangyoyeok-ro, Bundang-gu, Seongnam-si,
Gyeonggi-do, 13494 Korea
Phone: +82-31-696-7750
Fax: +82-31-696-7751

• **Australia**

Anritsu Pty Ltd.

Unit 20, 21-35 Ricketts Road,
Mount Waverley, Victoria 3149, Australia
Phone: +61-3-9558-8177
Fax: +61-3-9558-8255

• **Taiwan**

Anritsu Company Inc.

7F, No. 316, Sec. 1, NeiHu Rd., Taipei 114, Taiwan
Phone: +886-2-8751-1816
Fax: +886-2-8751-1817



Anritsu utilizes recycled paper and environmentally conscious inks and toner.



® Anritsu All trademarks are registered trademarks of their respective owners. Data subject to change without notice. For the most recent specifications visit: www.anritsu.com